

**CONTINENTAL MOTORS® AIRCRAFT ENGINE  
CRITICAL SERVICE BULLETIN**

**COMPLIANCE NECESSARY TO MAINTAIN SAFETY**

**CATEGORY 2  
CSB19-01**

**TECHNICAL PORTIONS  
FAA APPROVED**

- SUBJECT:** Fuel (Primer) Diverter Valve Assembly
- PURPOSE:** To assist Owners, Operators, and Maintenance Facilities with instructions to remove the fuel diverter valve assembly and provide available options to the fuel injection system for continued service.
- COMPLIANCE:** Within the next 25 hours of engine operation or the next scheduled inspection or engine servicing, whichever occurs first.

**MODELS**

**AFFECTED:** New and rebuilt Continental Motors (CMI) IO-360-ES; LTSIO-360-E, EB & KB; TSIO-360-E, EB, F, FB, G, GB, KB, LB, MB & SB; TSIO-520-BE and TSIO-550-A, B, C & E aviation gasoline (AvGas) engines

---

---

**I. GENERAL INFORMATION**

Continental Motors has received reports of fuel (primer) diverter valve malfunction that can result in a partial or complete loss of power.

The fuel diverter valve assembly allows a small quantity of fuel to accumulate in each induction manifold for engine priming and to improve starting efficiency. The panel-mounted PRIME switch commands the airframe boost pump, delivering fuel flow through the priming nozzles for current design pre-start priming.

Introduction of the cylinder drain connector serves the same priming function and allows the removal of the fuel diverter valve assembly from current production model specifications.

*CAUTION: Over-priming can lead to cylinder/piston hydrostatic lock. Reference the AFM/POH (Airplane Flight Manual/Pilot's Operating Handbook) for fuel mixture settings, priming times, proper engine ground starting and inflight restarting techniques to prevent inadvertent over-priming.*

**II. SCOPE**

This Service Document provides instructions to reroute fuel flow from the mixture control outlet directly to the fuel manifold valve assembly. This procedure will remove (bypass) the fuel diverter valve assembly from the fuel injection system and terminate electrical connections servicing the fuel diverter valve assembly.

This Service Document updates the manufacturer's Instructions for Continued Airworthiness (ICA) for determining "serviceable condition". This procedure should be added to the "Engine Fuel System Inspection Checklist" and a copy of this bulletin must be inserted into the most current version of the applicable Maintenance and Overhaul manuals (as listed in the "Models Affected") until the data is incorporated into the manual, by revision, or the service document is retired.

ISSUED	REVISED		PAGE NO	DOC NO	REVISION
2019/02/07		P.O. Box 90 Mobile, AL 251-436-8299	1 of 10	CSB19-01	

New engine configurations do not include the fuel diverter valve assembly, thus, do not require the procedures for Section III, “REMOVAL INSTRUCTIONS” except, where applicable, Step 3, to identify, remove, and terminate electrical harness and leads.

### III. REMOVAL INSTRUCTIONS

1. Verify your cross-flow engine has a fuel diverter valve assembly (P/N 633862-1, 642199-1, (14V), or 633862-2, 649268-2 (28V, as shown in Figure 1).

NOTE: Before removing the fuel diverter valve assembly or fuel manifold valve, either take a photograph or draw a sketch of the fuel injection fitting locations, positions, connections, electrical harness and connections for future reference (examples Figure 2 through Figure 4).

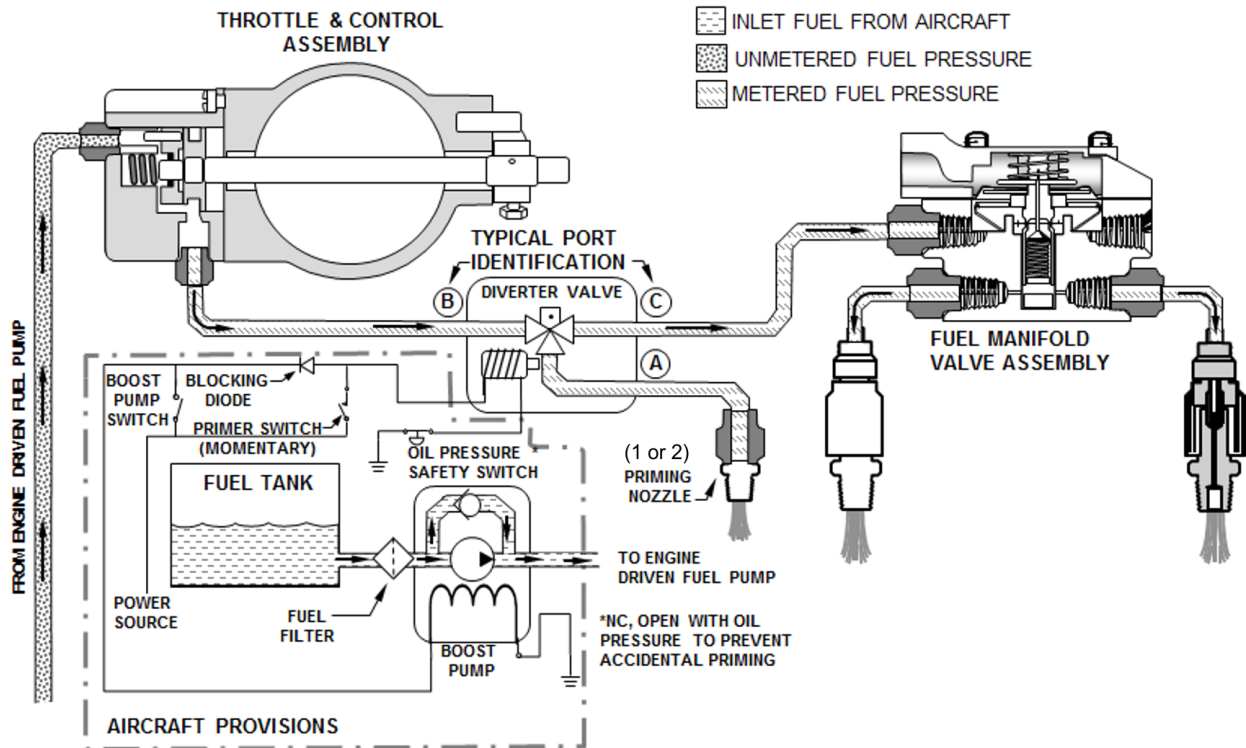

Figure 1. Fuel Diverter Valve Assembly, typical

2. Remove the fuel diverter valve assembly from service according to the latest revision of the applicable Maintenance and Overhaul Manual, Section 12 (engines as listed in the “Models Affected”).

NOTE: Return removed fuel diverter valve assembly to Continental Motors (see contact information provided in Section VI on page 10).

- a. Remove fuel diverter valve assembly (tubes and connectors) between the throttle and control assembly and fuel manifold valve assembly (see Figure 1, port identification B & C and Figure 2 through Figure 4, example configurations).
- b. Remove tube/hose assembly, as applicable, (see Figure 1, port identification A and Figure 2) between fuel diverter valve assembly and priming nozzle(s).
- c. Remove disconnected priming nozzle connector(s) and tube assemblies connected to induction system (location references see Figure 2 and Figure 7).

ISSUED	REVISED	 P.O. Box 90 Mobile, AL 251-436-8299	PAGE NO	DOC NO	REVISION
2019/02/07				2 of 10	CSB19-01

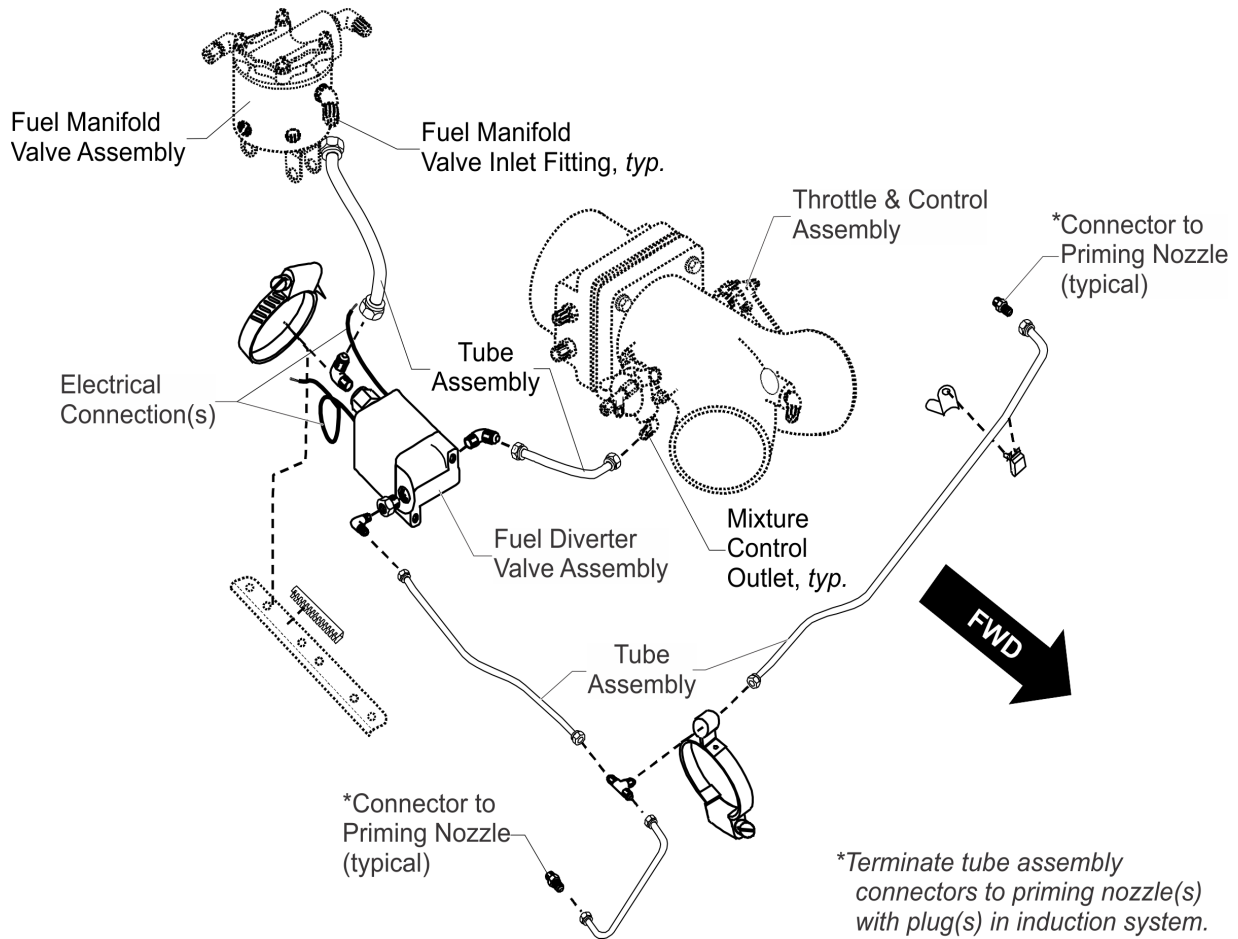

**Figure 2. Fuel Diverter Valve Assembly, TSIO-360-KB**

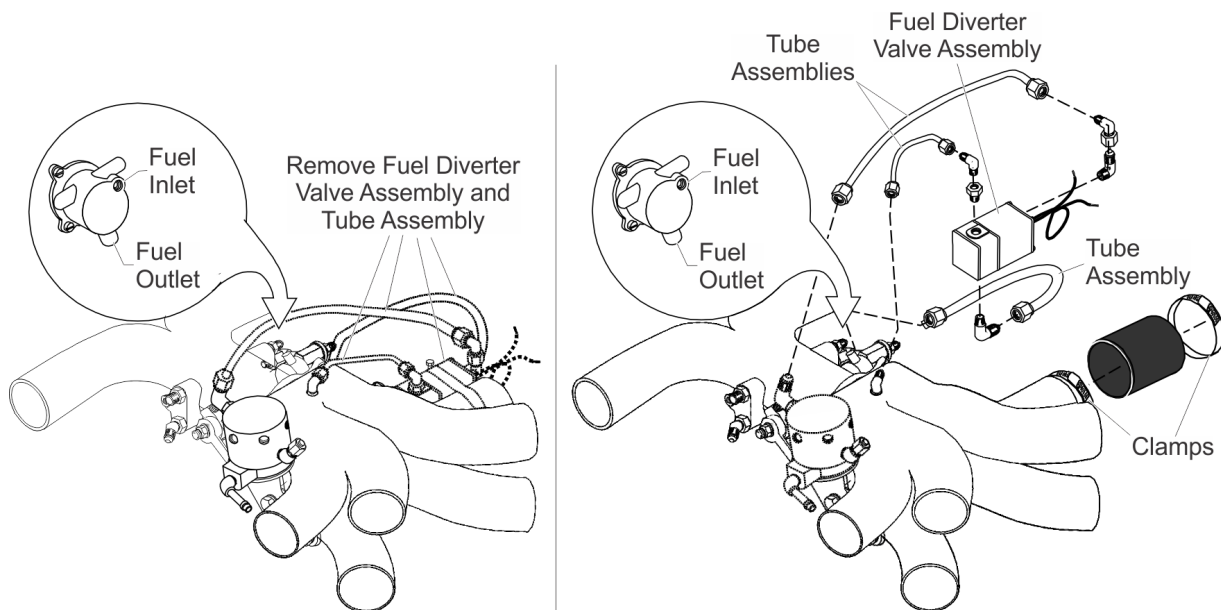

**Figure 3. Fuel Diverter Valve Assembly, TSIO-550-E**

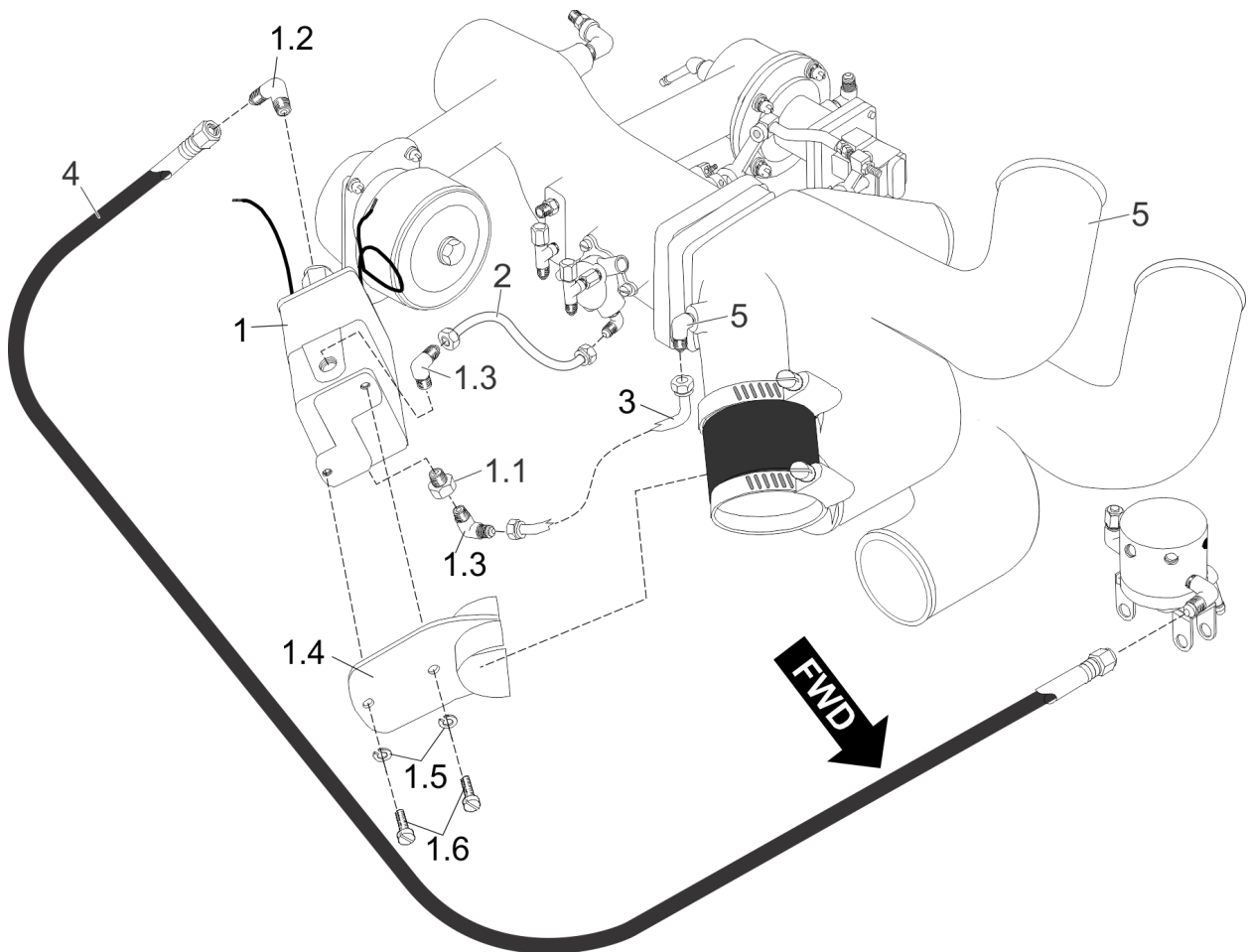

Figure 4. Fuel Diverter Valve Assembly, TSIO-360-MB

Table 1. Parts List, TSIO-360-MB

Item	Description	Qty
1	SOLENOID ASM	1
1.1	BUSHING-REDUCING 1/4-1/8	inc.
1.2	ELBOW	inc.
1.3	ELBOW-90 DEG X.25X.25-18	inc.
1.4	BRACKET - SOLENOID	inc.
1.5	WASHER LOCK-SPRING #8	inc.
1.6	SCREW-FILL HD	inc.
2	TUBE ASM-FUEL INJ	1
3	TUBE ASM-FUEL OUTLET	1
4	HOSE ASSEMBLY	1
5	MANIFOLD AND FITTING ASSY	1

3. Identify, remove, and terminate electrical harness and leads servicing the fuel diverter valve assembly, reference latest revision FAA Advisory Circular (AC) 43.13-1B, *“Acceptable Methods, Techniques, and Practices - Aircraft Inspection and Repair, Section 11”*. If the electrical harness information is unavailable, and if:
  - a. The harness has a connector at the firewall or baffle, terminate disconnected wires and properly insulate at the connector.
  - b. There isn't a harness connector, use PIDG caps (MS25274, appropriately sized) to terminate and insulate aircraft manufacturer's wire leads and secure harness.

NOTE: Wires should be routed so that fluids drain away from connectors or terminations. Conduits or flexible sleeving used to protect wiring must be equipped with drain holes to prevent entrapment of moisture.

#### IV. CYLINDER DRAIN CONNECTOR INSPECTION

The cylinder drain connector serves the same priming function as the primer diverter valve and allows the removal of the fuel diverter valve assembly from current production model specifications. Inspect for the current production cylinder drain connector (P/N 655742). The cylinder drain can be identified by a 0.060 deep punch mark in the wrenching flat (see Figure 5, P/N 655742).

1. If the cylinder drain is identified as P/N 655742, replacement is not necessary.
2. If the cylinder drain cannot be identified, perform an “Induction System Drain Inspection” according to M-0, Standard Practice Maintenance Manual, Section 6. If applicable, remove and replace cylinder drain connector(s) with current P/N 655742 (quantity based on number of engine cylinders).

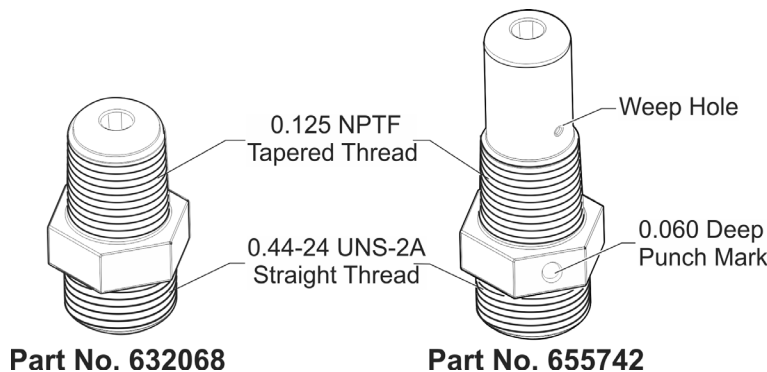

**Figure 5. Cylinder Drain Connector, P/N 632068 superseded by 655742**

3. Reference Section 7-4 of M-0, Standard Practice Maintenance Manual to perform engine operation under cold weather environments. If the engine has been exposed to temperatures below 20°F (-7 C) for more than 2 hours, preheat the engine according to “Engine Preheating” instructions in M-0, Standard Practice Maintenance Manual, Section 7-4. If the engine has been exposed to an ambient temperature between 20° to 40°F (-7° to 4° C), refer to the “Cold Weather Starting Without Preheating” instructions in Section 7-4.

<b>ISSUED</b>	<b>REVISED</b>	 P.O. Box 90 Mobile, AL 251-436-8299	<b>PAGE NO</b>	<b>DOC NO</b>	<b>REVISION</b>
2019/02/07			5 of 10	CSB19-01	

## V. INSTALLATION INSTRUCTIONS

**Follow all instructions in the primary ICA, including usage of sealants, lubricants, and adhesives, and application of fastener torque. Failure to comply with instructions for continued airworthiness may lead to catastrophic engine failure or death.**

*CAUTION: Avoid hose routing that allows strain, fatigue, chafing, or contact temperatures exceeding hose sheath limitations. Attach additional hose clamps where applicable (reference Table 5).*

1. Install new hose/tube assembly (reference Table 2 through Table 5 and Figure 6 through Figure 9) between throttle body (mixture control outlet) and fuel manifold valve inlet fitting.
2. Lubricate the hose/tube connector threads with clean 50 weight aviation engine oil.
3. Torque tube or hose fittings to the values specified in the latest revision of M-0, "Standard Practice Maintenance Manual, Appendix B."
4. Install plug(s) (reference applicable parts list tables) to terminate induction tube port(s). Lubricate the plug threads with Loctite® 592 PST thread sealant and torque to the values specified in the latest revision of M-0, "Standard Practice Maintenance Manual, Appendix B."

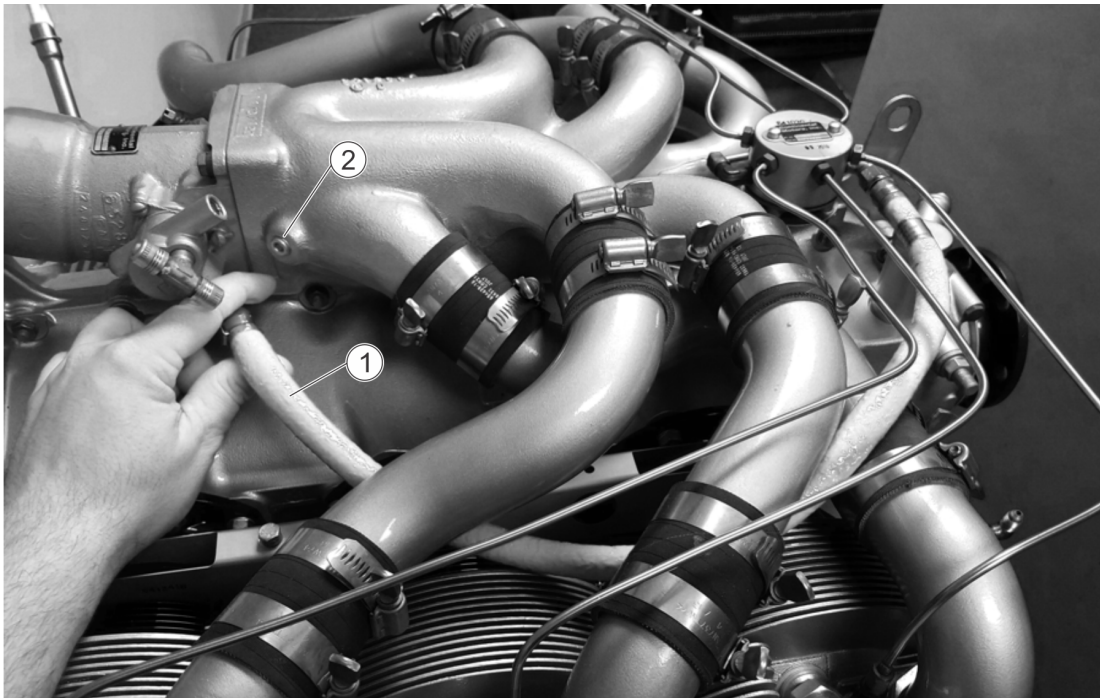

**Figure 6. Hose Installation, IO-360-ES; TSIO-360-MB, SB**

**Table 2. Parts List, IO-360-ES; TSIO-360-MB, SB**  
(reference Figure 6)

Item	P/N	Description	Qty
1	646644S4S24.00	HOSE ASSEMBLY	1
2	2024	PLUG,.13-27	1

<b>ISSUED</b>	<b>REVISED</b>	 P.O. Box 90 Mobile, AL 251-436-8299	<b>PAGE NO</b>	<b>DOC NO</b>	<b>REVISION</b>
2019/02/07			6 of 10	CSB19-01	



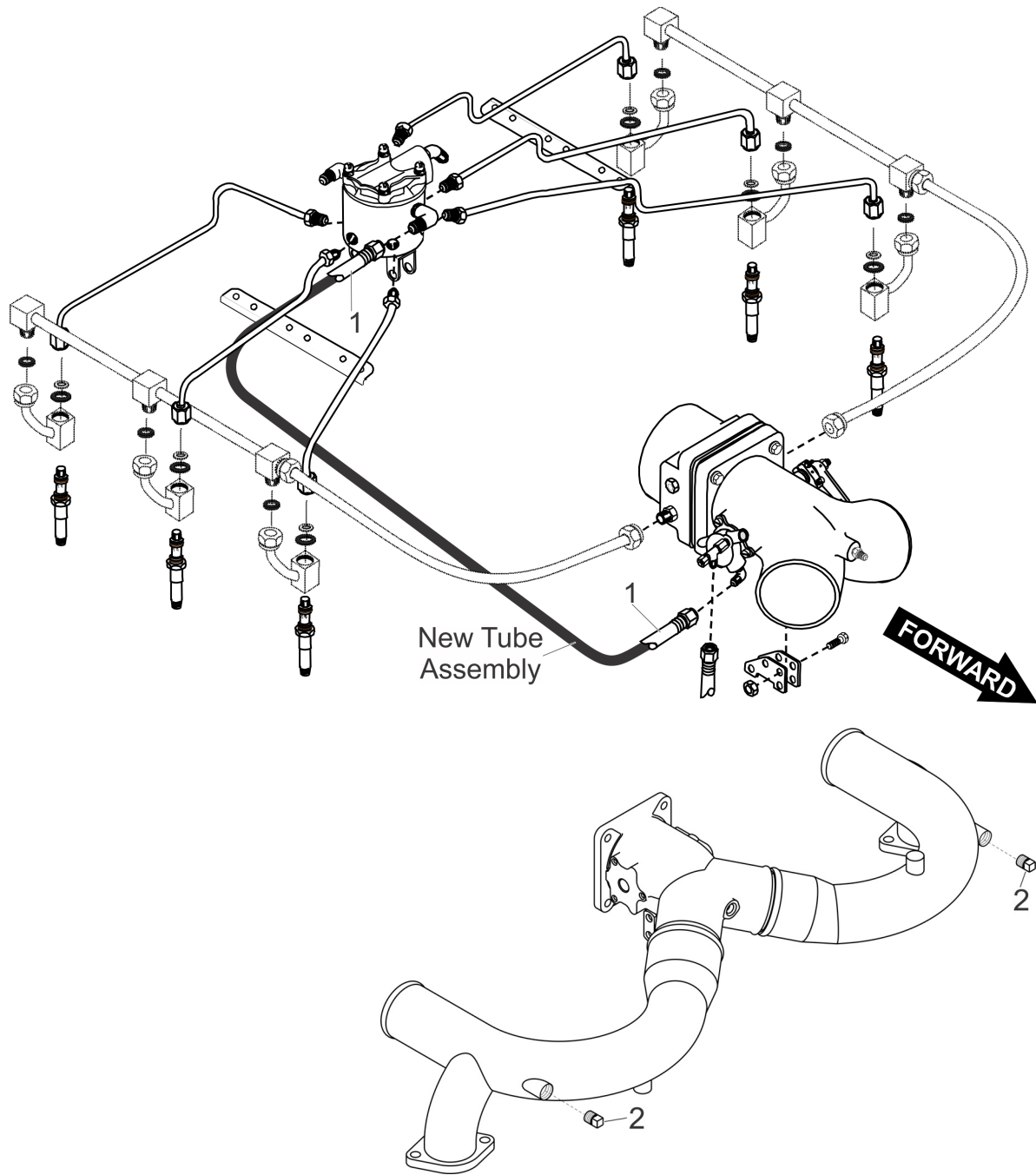
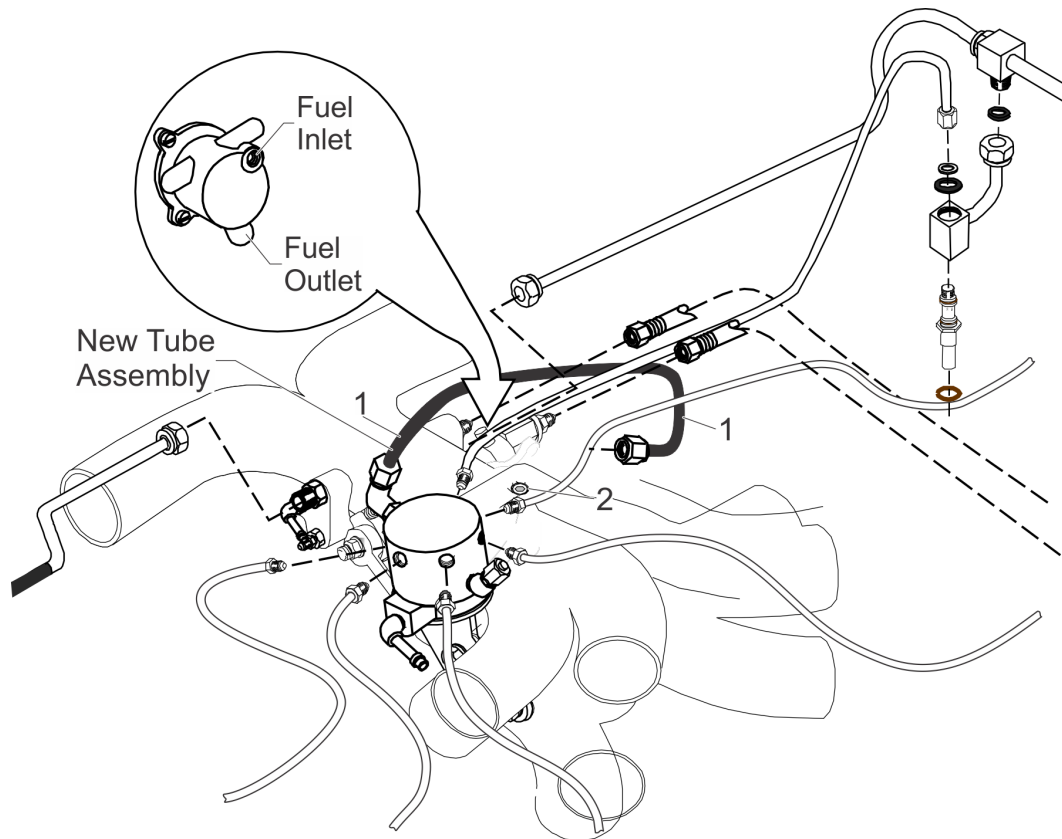

Figure 7. Tube Installation, LTSIO-360-E, EB, KB; TSIO-360-E, EB, F, FB, GB, KB, LB

Table 3. Parts List, LTSIO-360-E, EB, KB; TSIO-360-E, EB, F, FB, GB, KB, LB  
(reference Figure 7)

Item	P/N	Description	Qty
1	641085	TUBE ASM-MAN VALVE	1
2	629518-1	PLUG,.125 PIPE, SQ. HEAD (see also location, Figure 2)	2



**Figure 8. Tube Assembly Installation, TSIO-550-C (except C6B)**

**Table 4. Parts List, TSIO-550-C (except C6B)**  
(reference Figure 8)

Item	P/N	Description	Qty
1	656788	TUBE ASM-THROT TO MAN	1
2	2024	PLUG,.13-27 NPTF	1

- Reference Figure 9, to assemble the hose assembly (P/N 646644S6S23.00) and clamp assembly (fuel injection line bracket (item 2) for the TSIO-550-C6B engine. Loosen the induction clamp at the induction joint and insert bracket (item 2) under the induction clamp.
- Reposition the induction clamp on the induction tube and torque to the values specified in the latest revision of M-0, “Standard Practice Maintenance Manual, Appendix B.”

NOTE: If the clamp will not tighten or remain torqued to Appendix B specifications, the clamp is unserviceable, replace the induction clamp and perform a service inspection according to M-0, 6-4 “*Induction System Inspection.*”



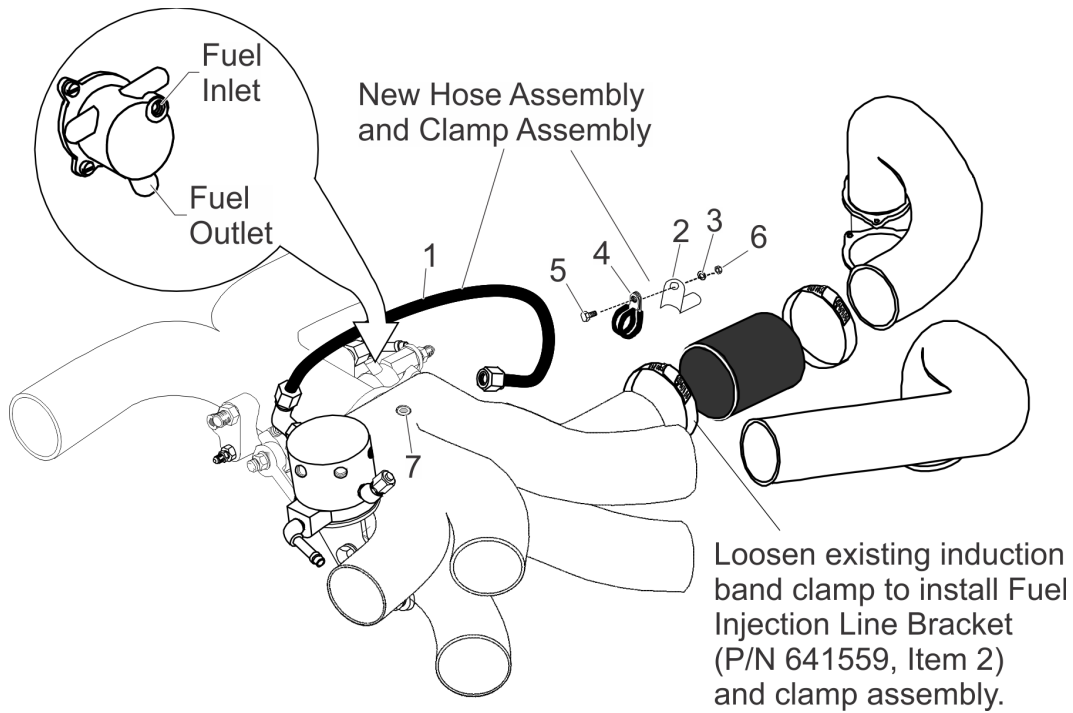

**Figure 9. Hose and Clamp Assembly, TSIO-520-BE; TSIO-550-A, B, C6B, E**

**Table 5. Parts List, TSIO-520-BE; TSIO-550-A, B, C6B, E**  
(reference Figure 9)

Item	P/N	Description	Qty
1	646644S6S23.00	HOSE ASM.	1
2	641559	BRACKET-FUEL INJ LINE	1
3	AN960-10L	WASHER-FLAT #10 THD	1
4	MS21919WDF14	CLAMP-LOOP CUSHIONED	1
5	AN3-4A	BOLT	1
6	MS21044N3	NUT-SELF LOCKING 10.32	1
7	2024	PLUG,.13-27 NPTF	1

7. Torque hose and clamp fittings to the values specified in the latest revision of M-0, “Standard Practice Maintenance Manual, Appendix B.”

**WARNING**

**Over-priming can cause a flooded intake resulting in a “hydraulic lock” event and subsequent engine malfunction or failure. If you over prime, or flood your engine, ensure excess fuel has drained from the intake manifold and/or cylinder prior to attempting engine starting.**

8. Verify fuel system operation and adjustment after completing the fuel diverter valve assembly removal. Perform an “Engine Operational Check” according to instructions in Section 6-4.7 of M-0, Standard Practice Maintenance Manual. Correct all discrepancies prior to release for flight.

9. Perform a flight check according to the Airplane Flight Manual/Pilot Operating Handbook (AFM/POH) before releasing the engine for normal service to ensure the installed engine meets the manufacturer's performance and operational specifications.
10. Create a logbook entry indicating compliance with this Service Document (CSB19-01).

## VI. WARRANTY

Standard warranty practices apply. Visit the Continental Motors web site at [www.continentalmotors.aero](http://www.continentalmotors.aero) to obtain copies of Continental Motors Warranty Policies.

Continental Motors reserves the right to request copies of invoices and maintenance records to verify warranty applicability.

### A. Allowances/Reimbursements

Eligible Allowance / Reimbursement Type	Labor Hours <sup>1</sup>	Parts
Replacement of affected hardware (as required, according to the Maintenance and Overhaul Manual hardware installation instructions)	2	inc.

1. at published shop rate

Contact Continental Motors Technical Services at one of the numbers listed below if you have any questions concerning the technical content of this Service Document.

1.888.826.5465 Toll Free in the United States  
 +1.251.436.8299 International Callers  
 +1.305.964.0872 En Español

<b>ISSUED</b>	<b>REVISED</b>		<b>PAGE NO</b>	<b>DOC NO</b>	<b>REVISION</b>
2019/02/07		P.O. Box 90 Mobile, AL 251-436-8299	10 of 10	CSB19-01	